

Toure Fixed Shower Door with windowpane design Installation Instructions

Size:39"x77"



ella
by ella's bubbles

- Please read these instructions in full before installation

IMPORTANT







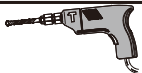

- Check that the shower surround has been installed to the manufacturer's instructions. Please note - All product is supplied without a tray.
- Opening wall adjustments

Adjustment =38.58"-38.97"x77"[(980-990)x1950mm]

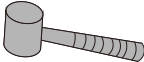
GENERAL SAFETY INSTRUCTIONS

- Do not fix the wall profile to newly plastered, painted or papered walls as chemical reaction may cause discoloration to the surface finish.
- Important: The wall plugs included in this pack are for solid walls only. If the product is to be mounted on a partition or stud wall, specialized fixings should be purchased separately.
- Fixing tips; A piece of insulating tape or a couple of layers of masking tape applied to the wall before marking out the fixing holes will help stop the drill from wandering, particularly on tiled surfaces.
- When working near a basin or bath insert the plug into the drain, this will help you avoid losing small parts. Also take care not to drop accessories or tools onto the bath or basin, use a towel or bathmat to protect delicate surfaces.
- CAUTION!
Before drilling into any walls check that there are no hidden cables or pipes. Exercise great care when using power tools near water. The use of a residual current device (RCD) or cordless drill is recommended. Always double check the positioning and measurements before drilling holes.
- This product is heavy and requires two people during lifting and operations.
- Glass is delicate, support on cardboard to minimize risk of damage.

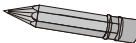





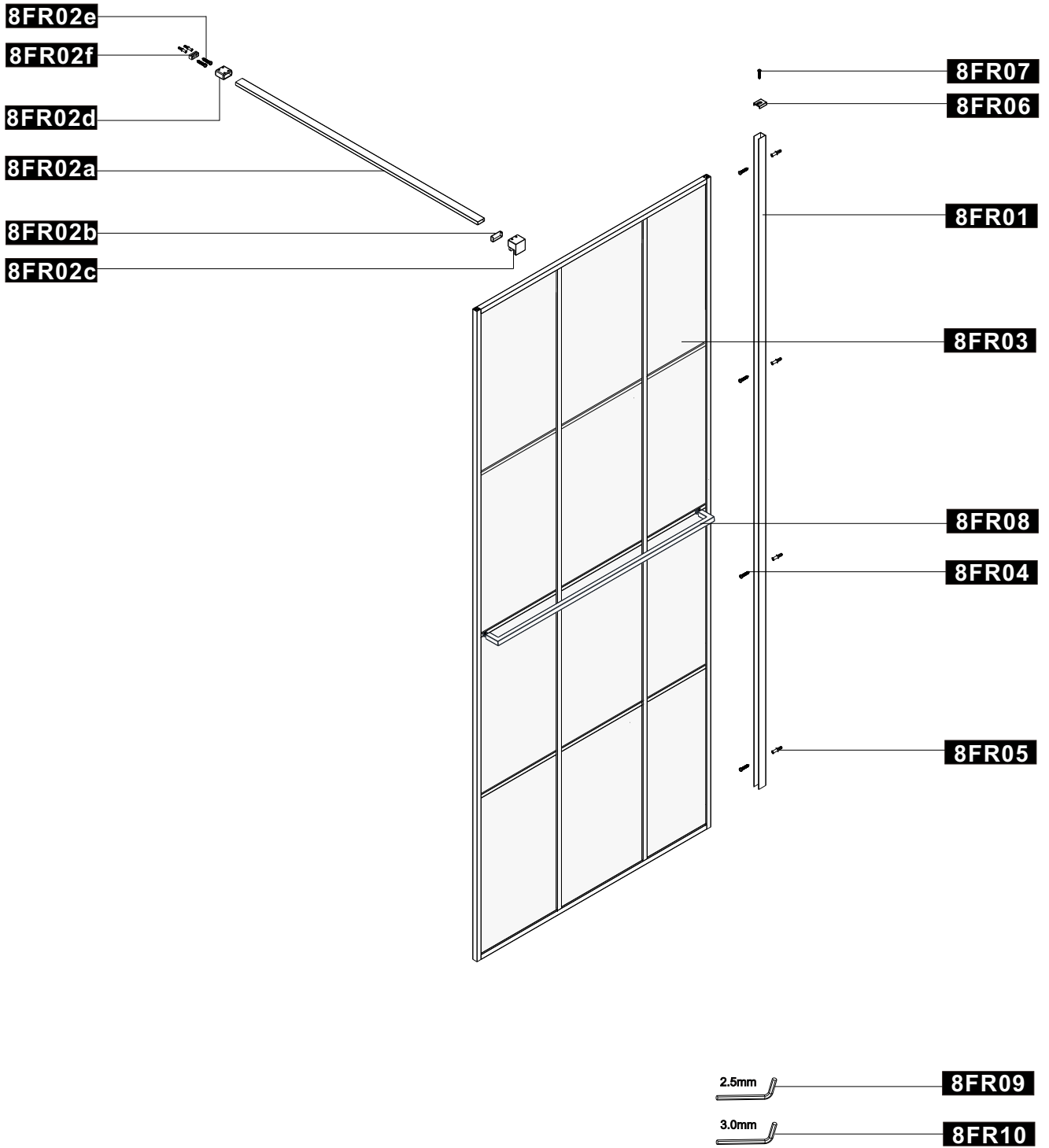





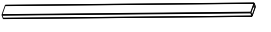

Tools required (not supplied)

Electric drill		Tape measure	
Drill(Ø3.2mm)		Rubber hammer	
Drill(Ø6mm)		Knife	
Cross head screw driver		Pencil	
Spirit level		Silicone sealant	

IDENTIFICATION OF PARTS

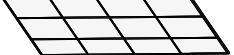

Fixings & fittings supplied

Item No.:	Part	Quantity	Item No.:	Part	Quantity
8FR01		X1	8FR04	 ST4.0x30	X4
8FR02a		X1	8FR05		X6
8FR02b		X1	8FR06		X1
8FR02c		X1	8FR07	 ST3.5x35	X1
8FR02d		X1	8FR08		X1
8FR02e	 ST4.0x30	X2	8FR09	 2.5mm	X1
8FR02f		X1	8FR10	 3.0mm	X1
8FR03		X1			

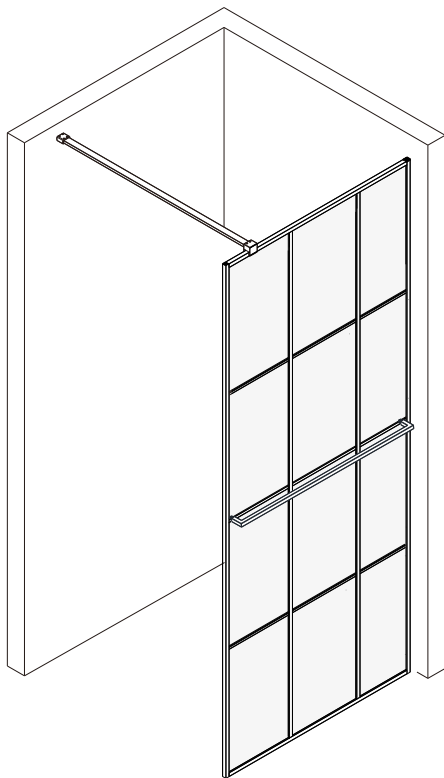

RH

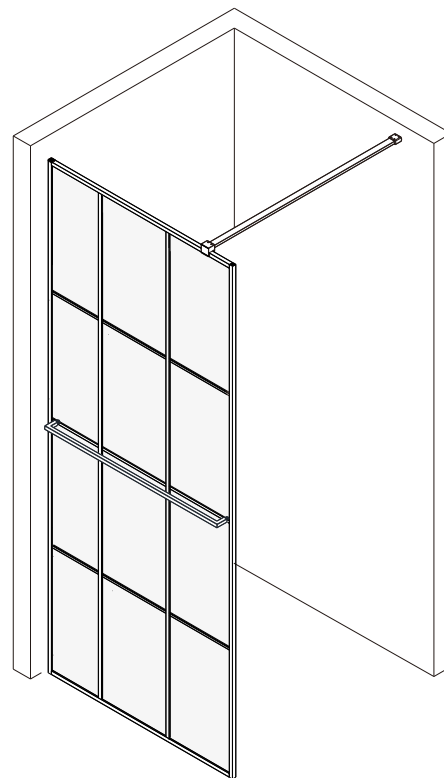

LH

The Cross Frame walk in can be installed on the left or right hand side. The steps below are based on the Right hand. Please choose the direction and follow the steps below in reverse if you are installing on the left hand side.

1

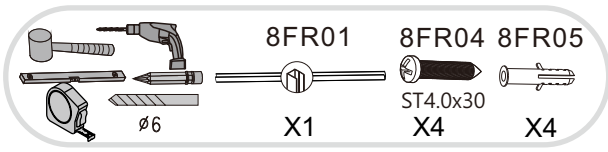

- Put the wall profile 8FR01 against the wall and ensure it is vertical using a spirit level.
- Drill the holes(ø6mm)accordingly.
- Insert wall plugs 8FR05(4x) into the holes.
- Fasten the wall profile on the wall with screws 8FR04(4x).

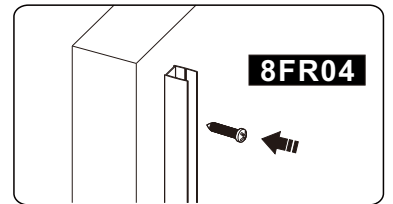
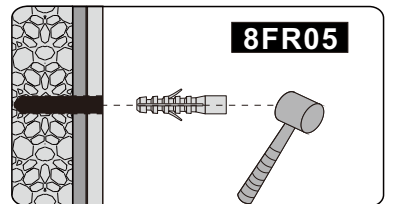
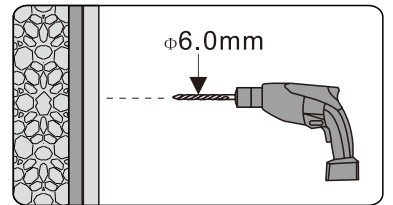
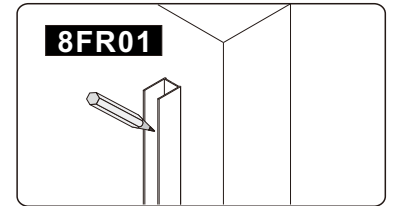
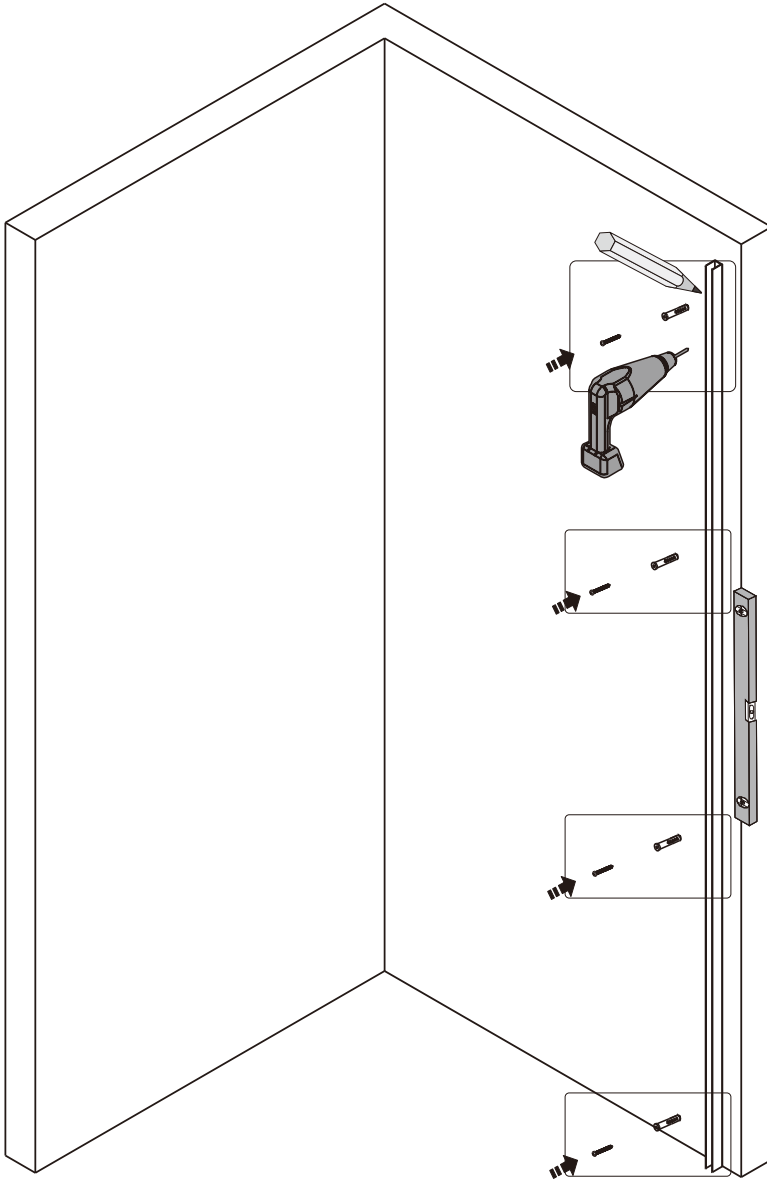

2.

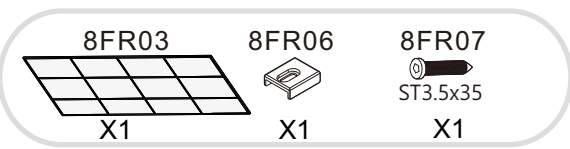

-Insert the cross framed walk in panel 8FR03 into the wall profile.
Put the top cover 8FR06 on the wall profile ,and fasten it with screw 8FR07.

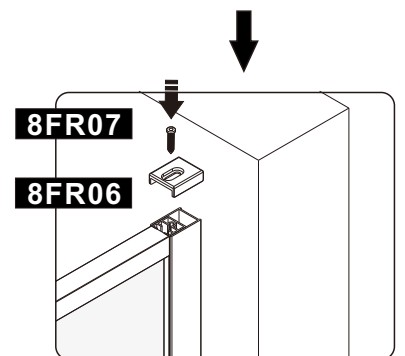
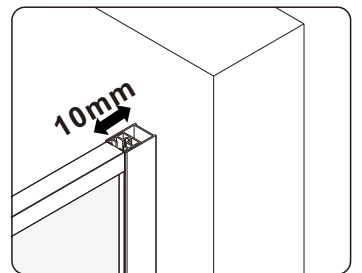
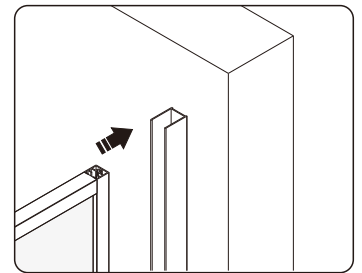
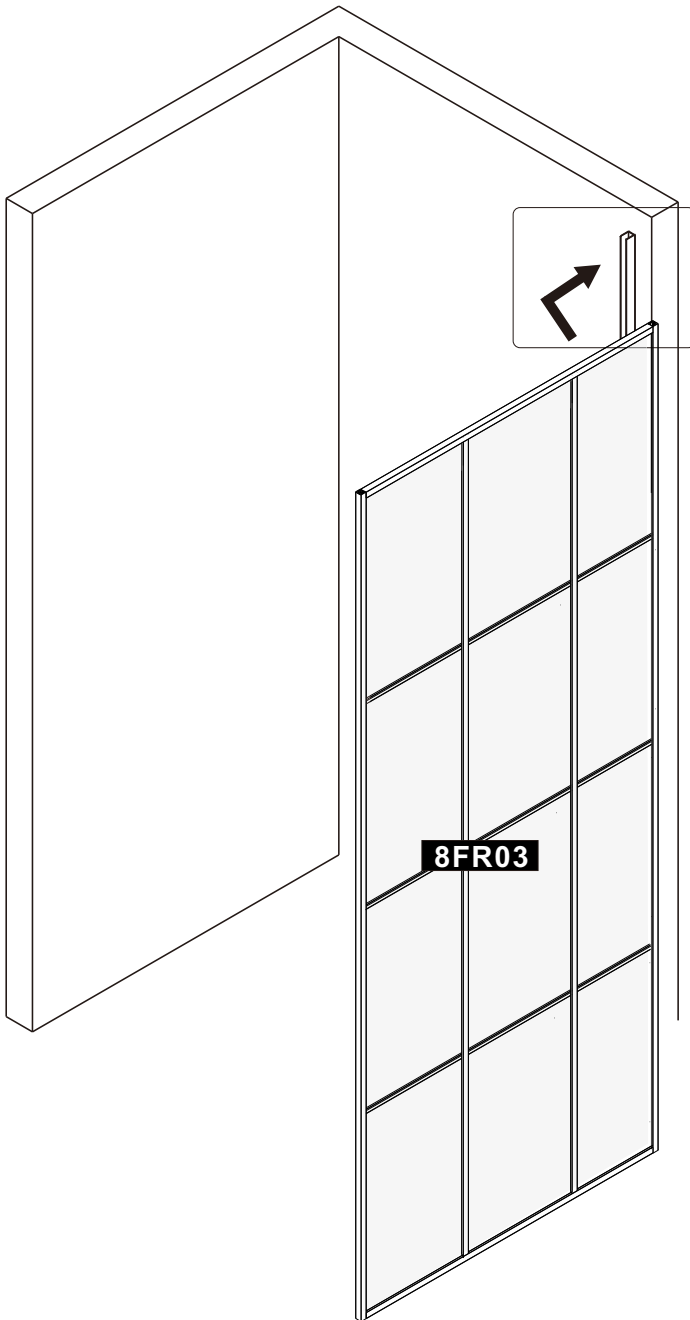

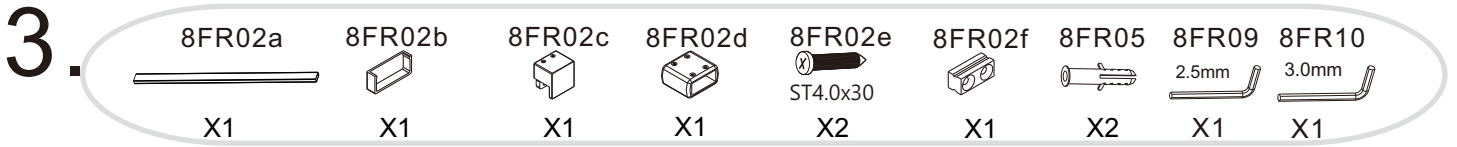

- Put the glass clip 8FR02c on the panel, then fasten the bottom of the clip with inner screws using hex key 8FR10.
- Insert one side of support bar 8FR02a into the glass clip.
- Attach the wall bracket 8FR02d on the other side of support bar, ensure it is level using a spirit level, and mark the position of wall bracket on the wall.
- Take off the wall bracket from support bar and mark the holes' position on the wall.
- Drill the holes($\phi 6\text{mm}$)on the wall accordingly,and insert the wall plugs 8FR05(2x) into the holes.
- Fix the wall bracket seat 8FR02f on the wall with screws 8FR02e.
- Put the bottom cover 8FR02b on the glass clip and fasten one side of support bar into the glass clip with inner screws using hex key 8FR10.
- Insert the other side of the support bar into wall bracket 8FR02d and wall bracket seat 8FR02f, and fasten them with inner screw using hex key 8FR09.

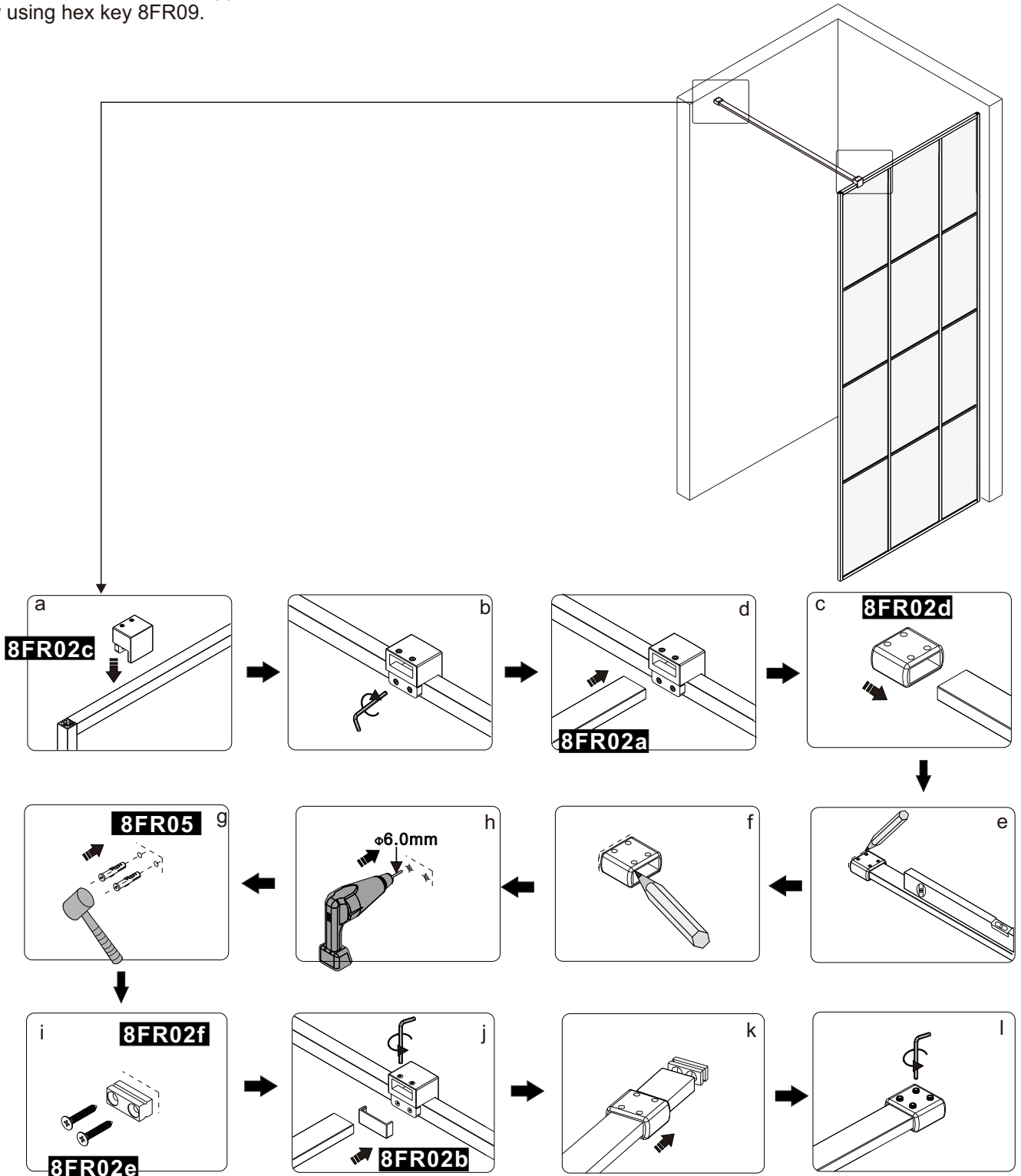

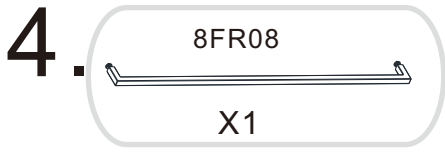

-Mount the towel bar 8FR08 onto the glass panel.

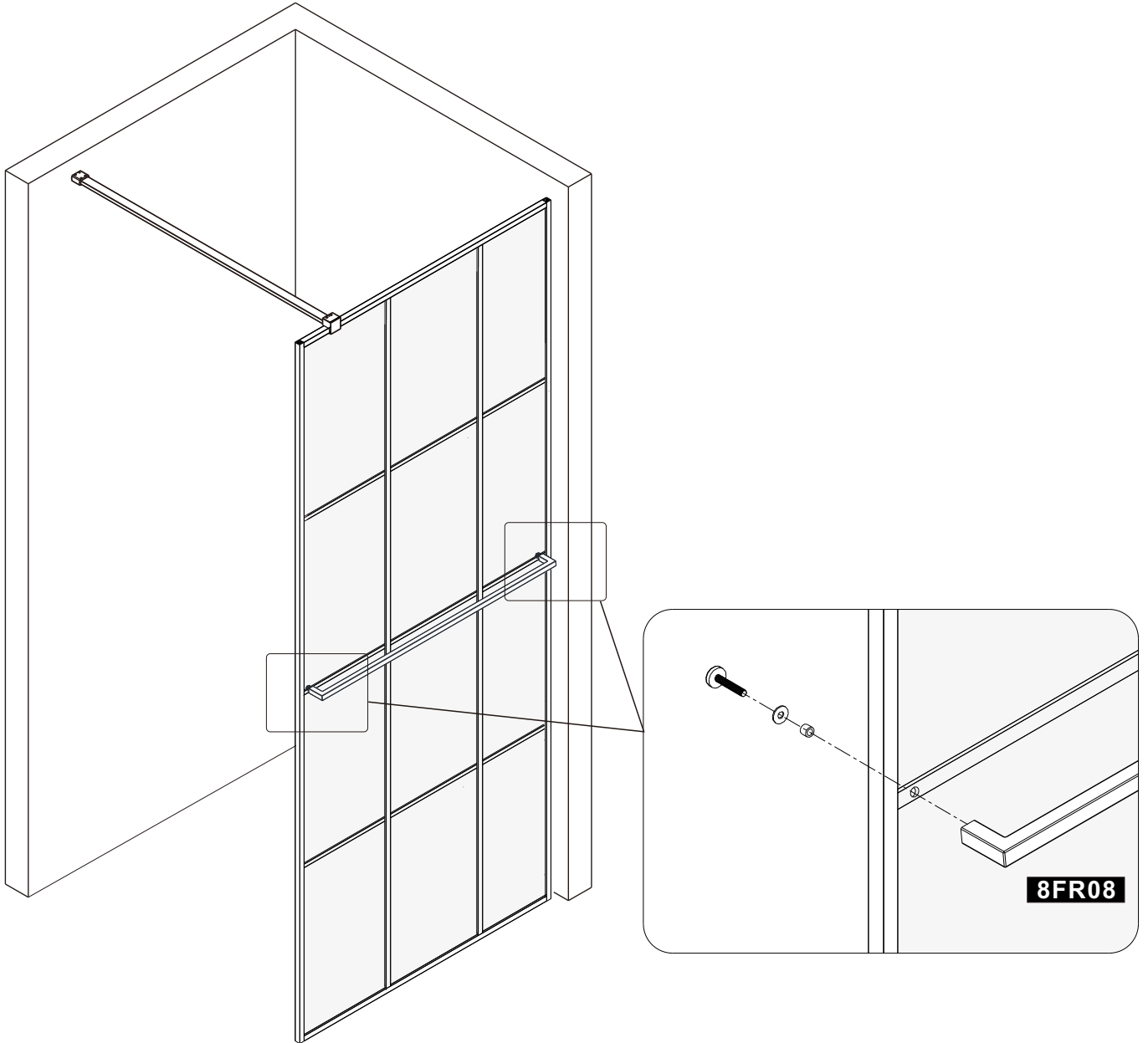

5.

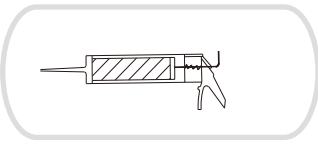

- Apply silicone sealant to the outside of the enclosure.
- Please note: Do not apply silicone sealant to the inside of the enclosure.
- Do not take a shower within the 24 hours after applying the silicone sealant.

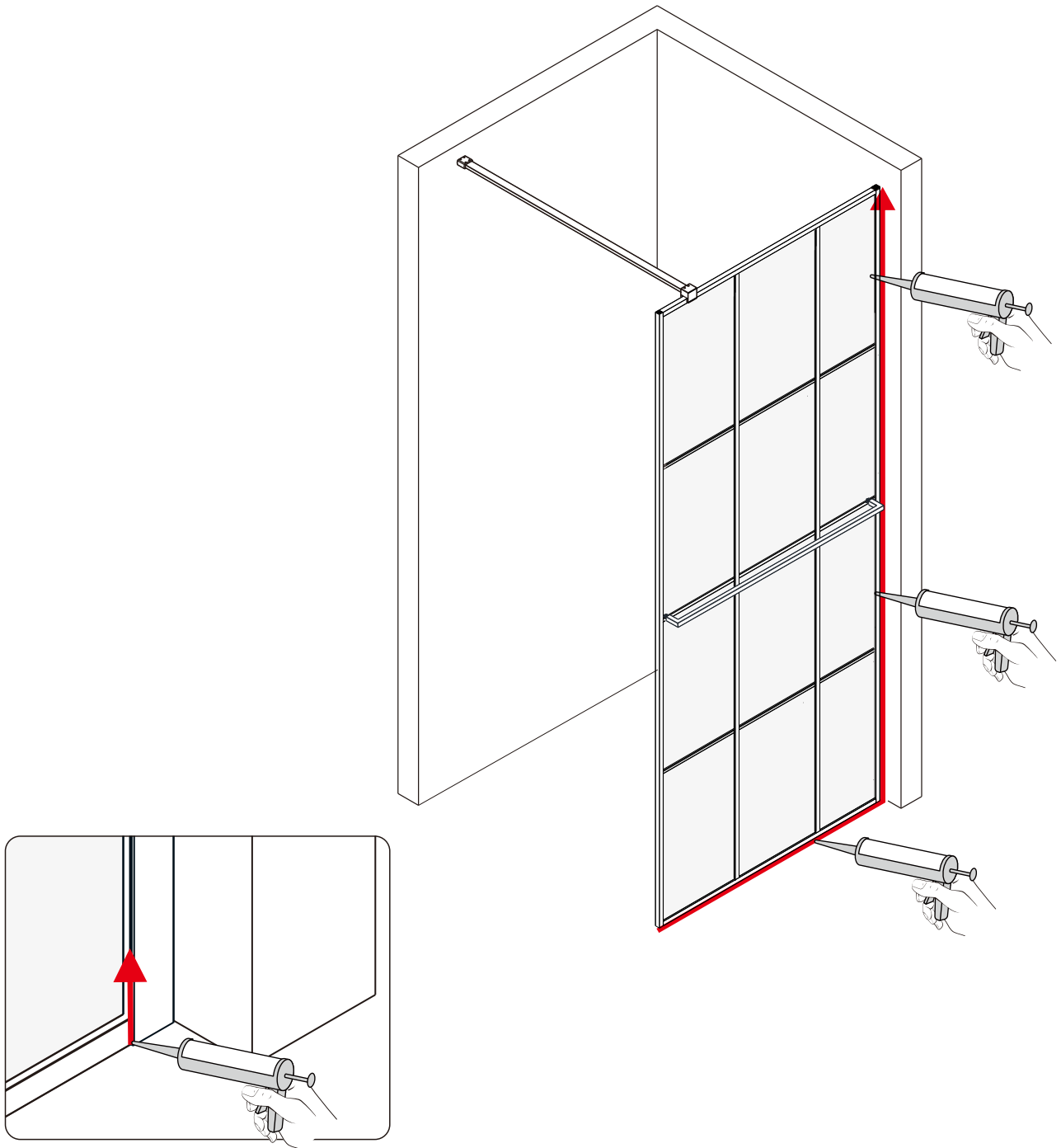

Cleaning and Maintenance:

Please do not use abrasive or strong cleaning solution on the shower enclosure, such as alcohol, petroleum liquids or any other chemical cleaner with acidic contents.

Should there be any dirty stains on the shower enclosure, please clean it with a soft lint free cloth and warm soapy water. Please rinse it with clean water afterwards.

After the installation is complete, if there is any noise during glass door movement, please add a small quantity of lubricant onto the roller wheel, bottom guide and track where applicable.

After installation is complete and you are still encountering problems with your enclosure, our sales technicians will be happy to assist.

Technical and Customer Support: 800.480.6850