

# Sliding Shower Door/6mm Installation Instructions

Size:48"x72"

60"x72"



**ella**  
by ella's bubbles

- Please read these instructions in full before installing







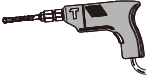

## IMPORTANT

- Check that the bathtub has been installed to the manufacturer's instructions. Please note - All product is supplied without a tray.
- Opening wall adjustments  
48"Slider - adjustment = (46.50"-47.44")x72"  
60"Slider - adjustment = (58.19"-60")x72"

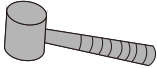
## GENERAL SAFETY INSTRUCTIONS

- Do not fix the wall profile to newly plastered, painted or papered walls as chemical reaction may cause discolouration to the surface finish.
- Important: The wall plugs included in this pack are for solid walls only. If the product is to be mounted on a partition or stud wall, specialised fixings should be purchased separately.
- Fixing tips; A piece of insulating tape or a couple of layers of masking tape applied to the wall before marking out the fixing holes will help stop the drill from wandering, particularly on tiled surfaces.
- When working near a basin or bath insert the plug into the waste, this will help you avoid losing small parts. Also take care not to drop accessories or tools onto the bath or basin, use a towel or bathmat to protect delicate surfaces.
- CAUTION!  
Before drilling into any walls check that there are no hidden cables or pipes. Exercise great care when using power tools near water. The use of a residual current device (RCD) or cordless drill is recommended. Always double check the positioning and measurements before drilling holes.
- This product is heavy and requires two people during lifting and operations.
- Glass is delicate, support on cardboard to minimise risk of damage.

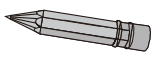





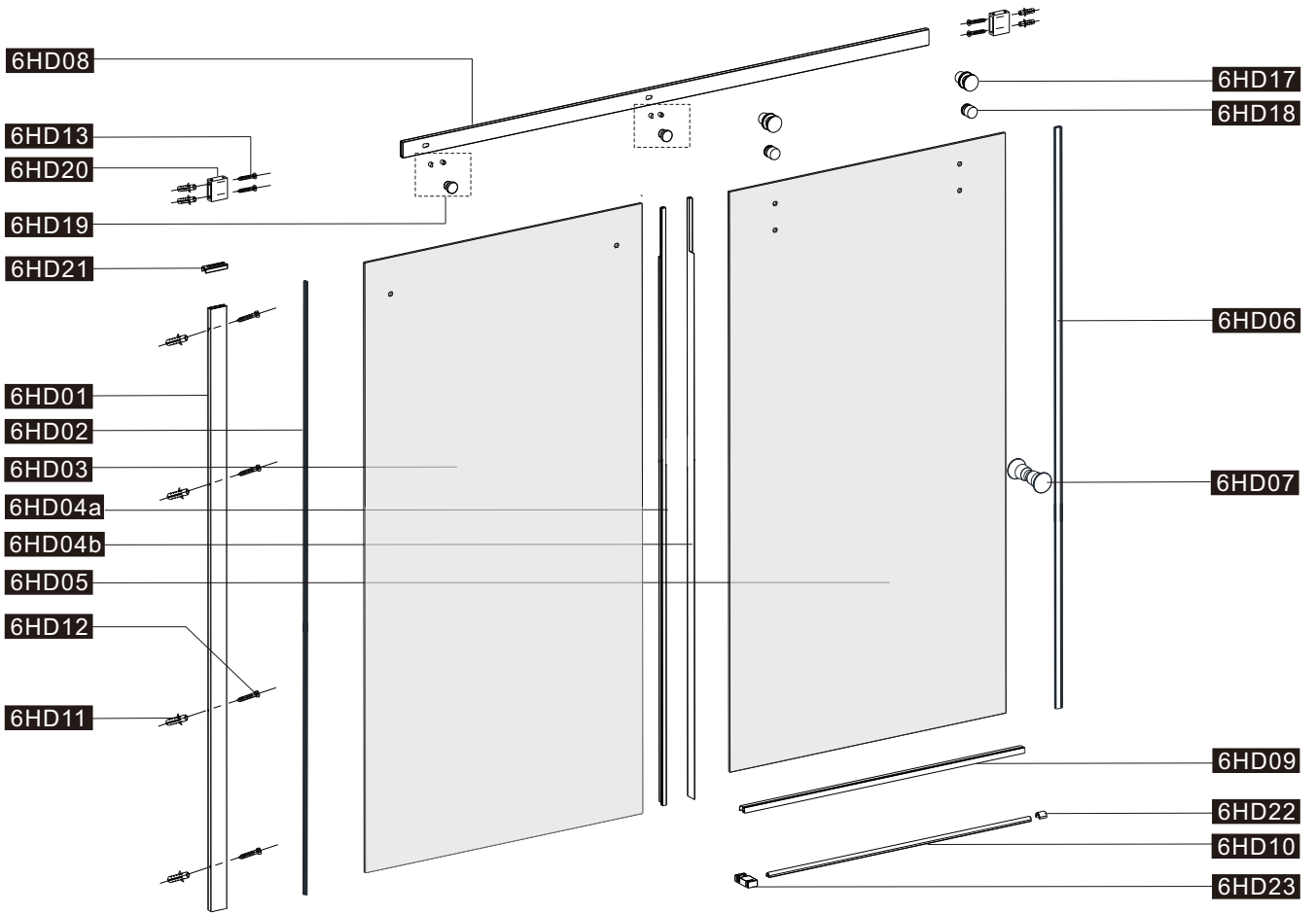





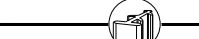

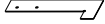

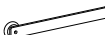



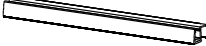

## Tools required (not supplied)

Electric drill		Tape measure	
Drill(Ø3.2mm)		Rubber hammer	
Drill(Ø6mm)		Knife	
Cross head screw driver		Pencil	
Spirit level		Silicone sealant	

# IDENTIFICATION OF PARTS



## Fixings & fittings supplied

Item No.:	Part	Quantity	Item No.:	Part	Quantity
6HD01		X 1	6HD13	 ST4X40	X 4
6HD02		X 1	6HD14		X 2
6HD03		X 1	6HD15		X 1
6HD04		X 2	6HD16		X 1
6HD05		X 1	6HD17		X 2
6HD06		X 1	6HD18		X 2
6HD07		X 1	6HD19		X 2
6HD08		X 1	6HD20		X 2
6HD09		X 1	6HD21		X 1
6HD10		X 1	6HD22		X 1
6HD11		X 8	6HD23	 L R	X 1
6HD12	 ST4X40	X 4	6HD24	 4 2.5	X 1

## Technical Drawing

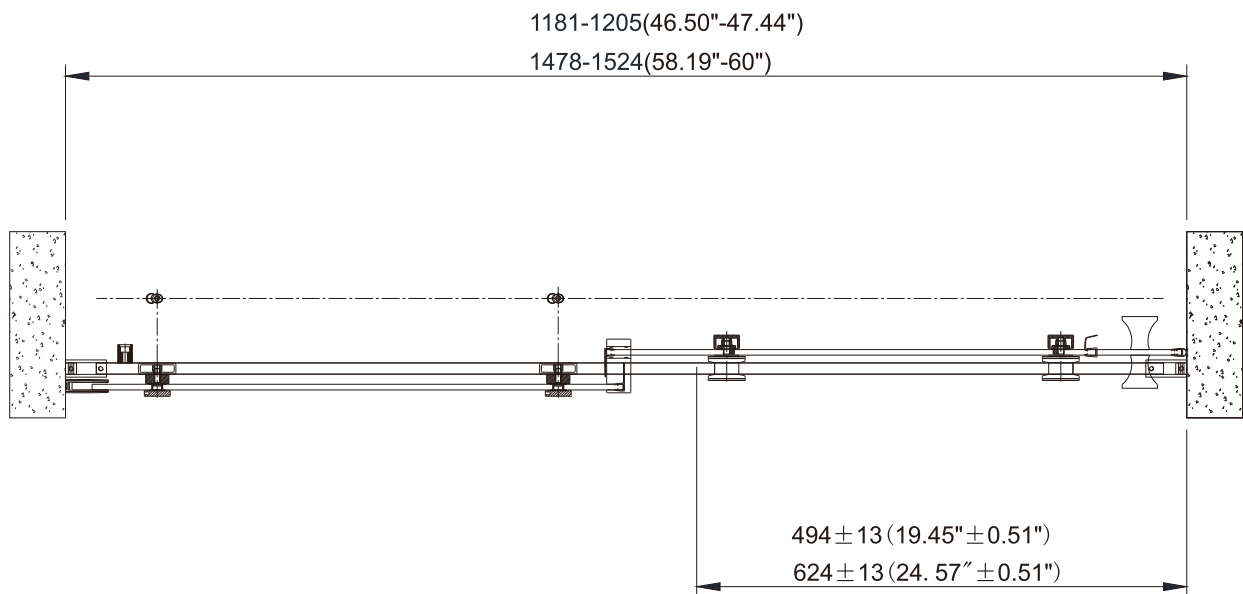

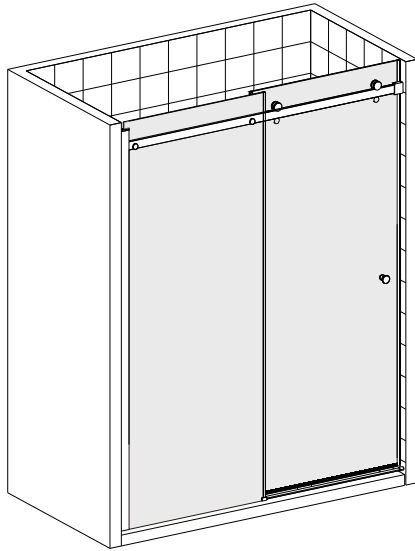

**RH**

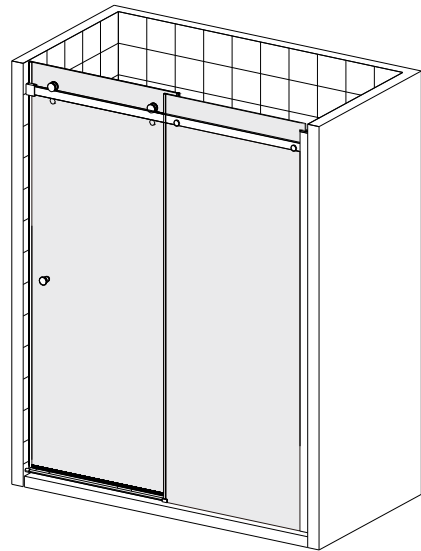

**LH**



Halo screen is reversible for Left hand and Right hand. But the mounting instruction is the same for both directions. Below step is followed by Right hand. For left hand, please follow below steps in mirror direction.

- 1** - Measure the wall with spirit level to make sure the wall is vertical.
- a. Put the wall profile 6HD01 against the wall, ensuring the distance between the profile and the base edge is correct. Adjust the profile to make sure it is vertical by using a spirit level. Mark the fastening holes on the wall.
  - b. Drill the holes ( $\phi$  6mm) according to the marks and insert the wall plugs 6HD11(4X) into the holes.
  - d. Apply silicone down the whole length on the back of wall profile 6HD01.
  - e. Fixing wall profile on the wall with screws 6HD12(4X)

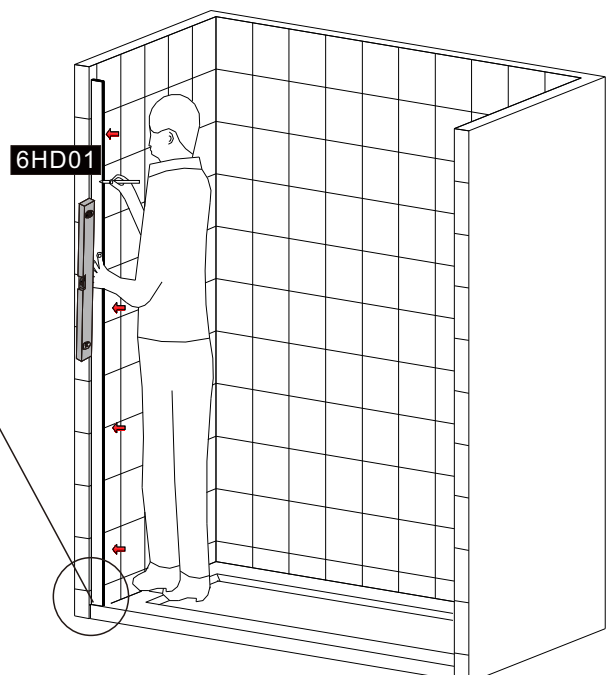
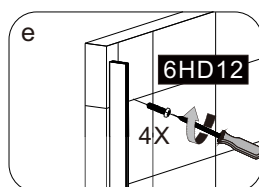
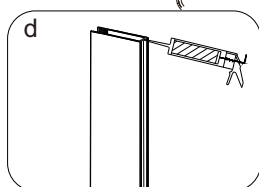
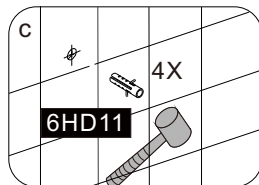
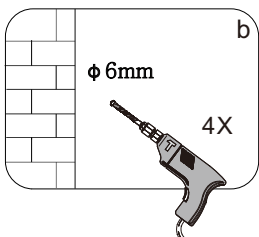
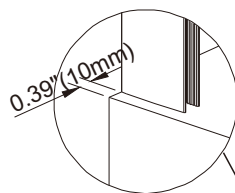
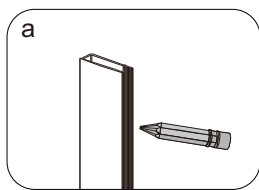
6HD01		X 1
6HD11		X 4
6HD12		X 4



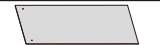

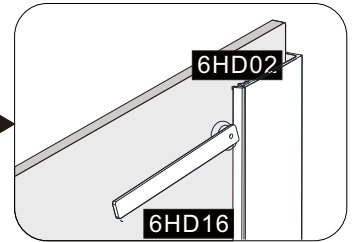
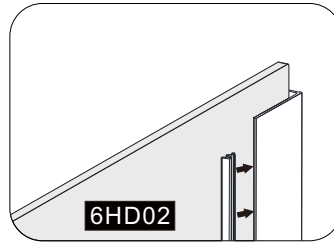
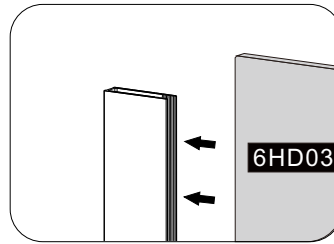
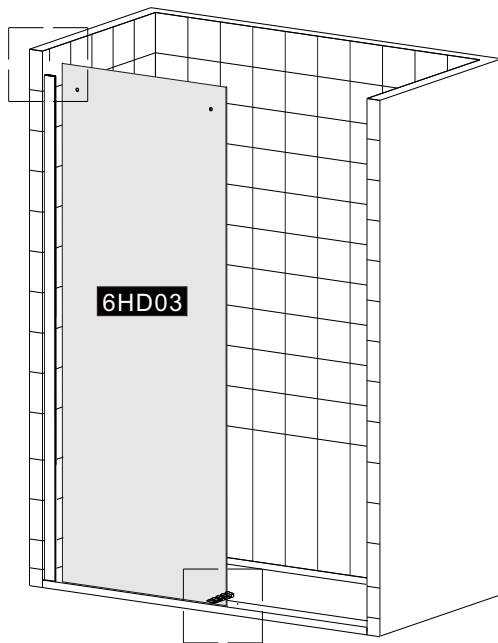

- 2.** -Insert fixed glass panel 6HD03 into the wall profile.  
 - Then insert single blade seal 6HD02 from the inside of cabin between wall profile and glass panel with tool 6HD16.

6HD03		X 1
6HD02		X 1
6HD16		X 1

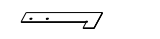

- 3.** a. Mark the holes position of the rail profile wall seat by using tool 6HD15.  
 b. Drill the holes(  $\phi$  6mm) accordingly.  
 c. Insert the wall plugs 6HD11(2X) in the holes.  
 d. Fix rail profile seat 6HD20 on the wall with screws 6HD13(2X).

6HD15		X 1
6HD11		X 2
6HD13	 ST4X40	X 2
6HD20		X 1

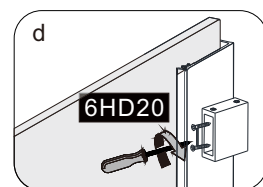
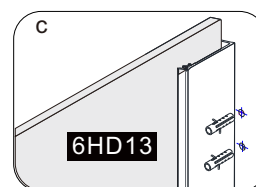
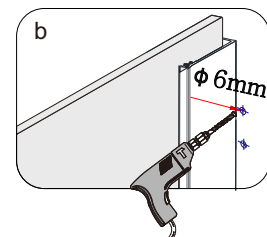
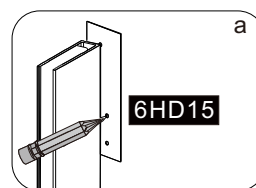
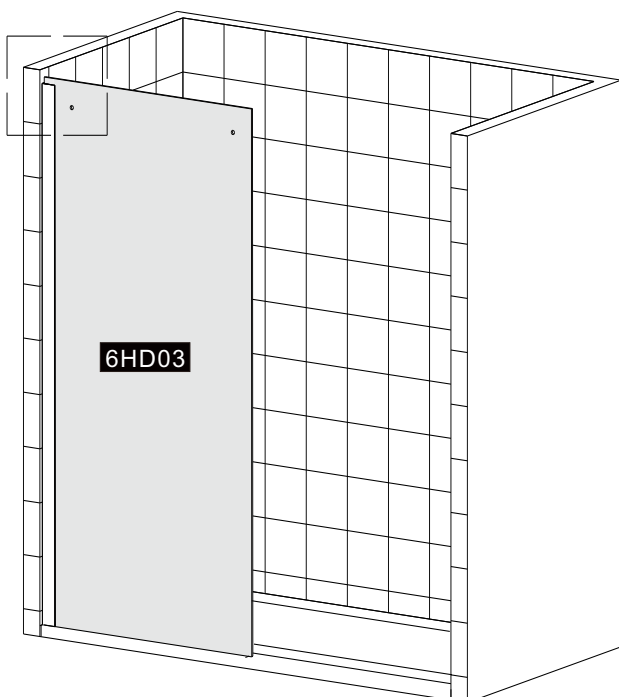

- 4**
- Loose the back nut E of 6HD19 to disassemble 6HD19 to part E, F and G. Insert back nut E into the holes on the rail profile.
  - Peel off the skin of paper on the F. Insert F also into the hole to fix nut E tightly on the rail profile.
  - Disassemble wall bracket 6HD20 to part H and I with hex key 6HD24.
  - Put part H on the other end of rail profile 6HD08.

6HD19		X 2
6HD24		X 1
6HD20		X 1

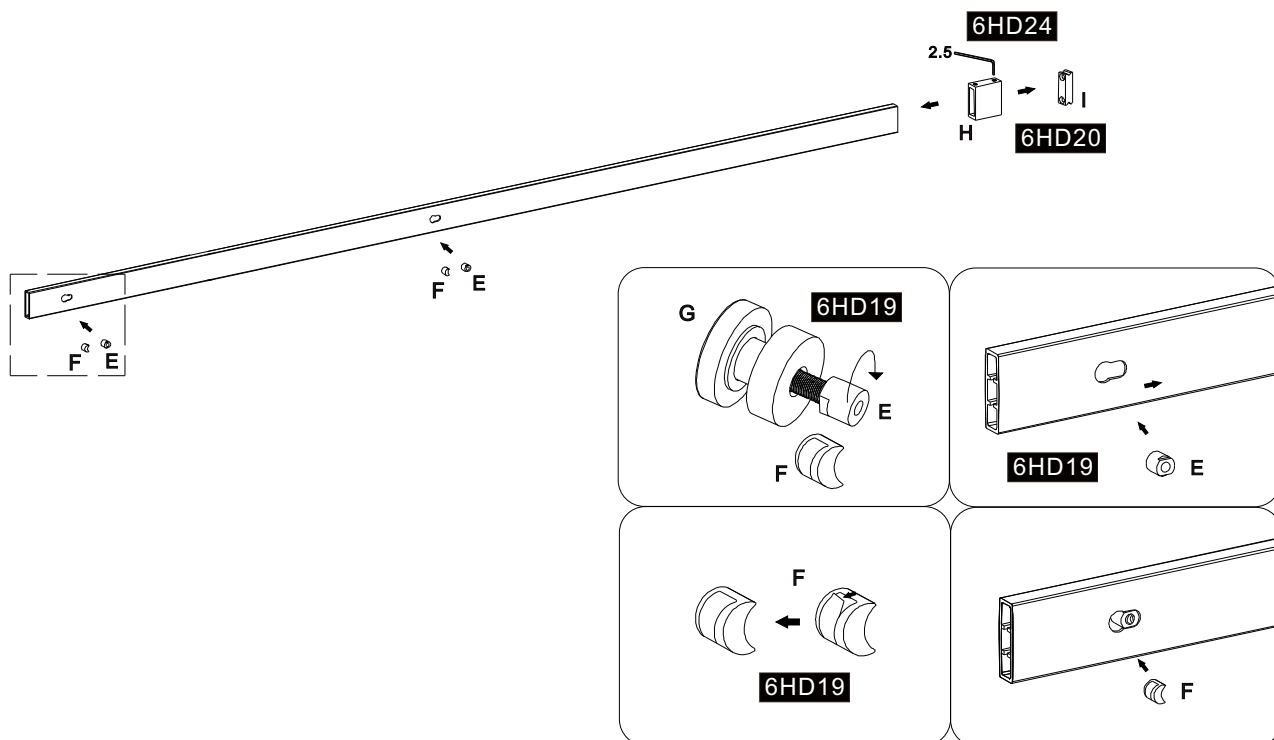

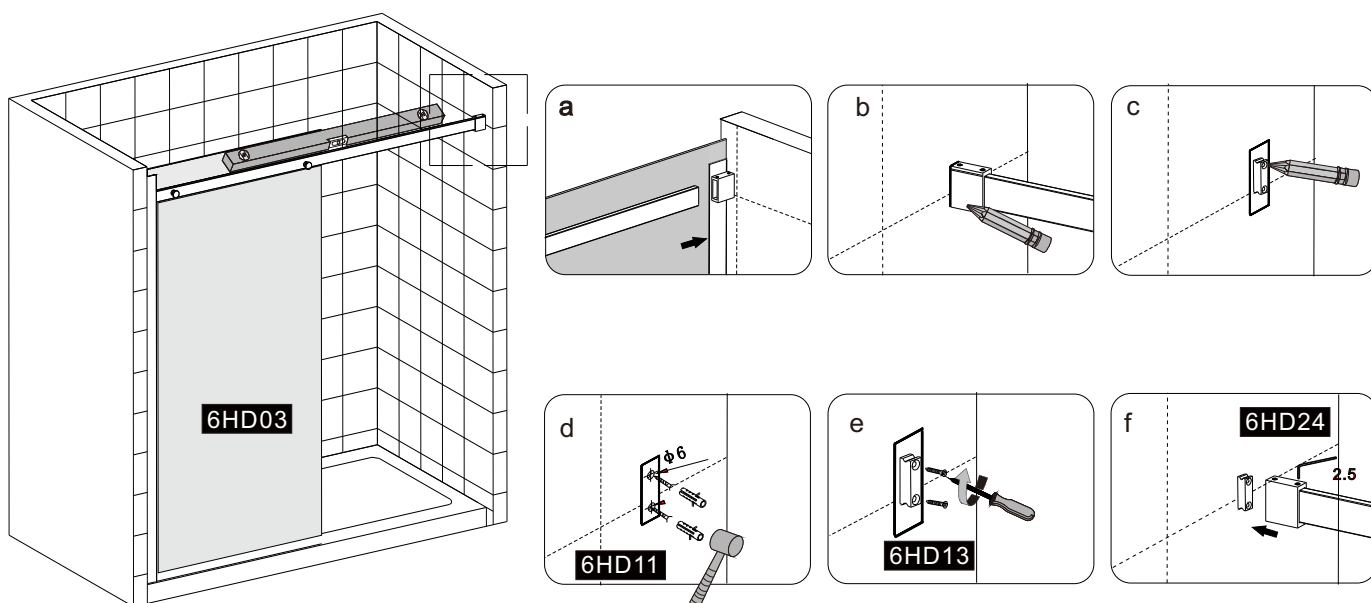

- 5**
- Insert the rail profile into wall bracket of fixed glass panel side.
  - Measure the rail profile with spirit level to make sure the rail profile is horizontal. Match the holes on rail profile and fix glass panel.
  - Mark the position of 6HD20 accordingly.
  - Drill the holes ( $\phi 6$ mm) according to the marks and insert the wall plugs 6HD11(2X) into the holes.
  - Fix the seat I on the wall with screw 6HD13(2X)
  - Fasten the wall bracket with seat by hex key 6HD24.

6HD11		X 2
6HD13		X 2
6HD24		X 1



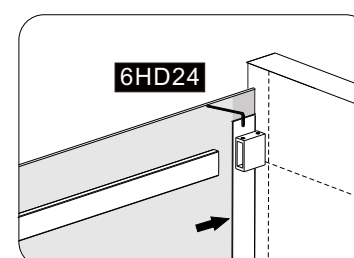
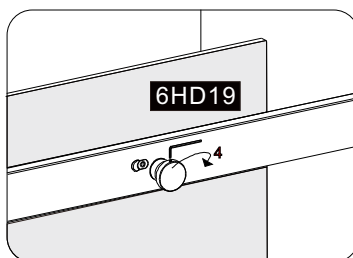
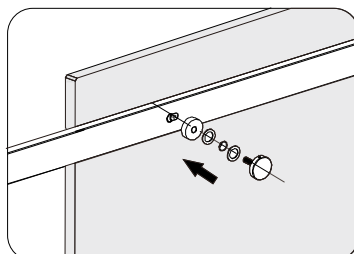
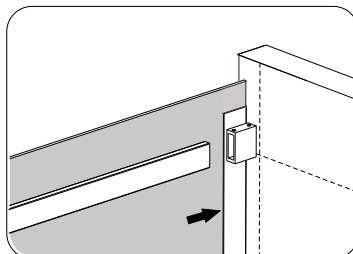
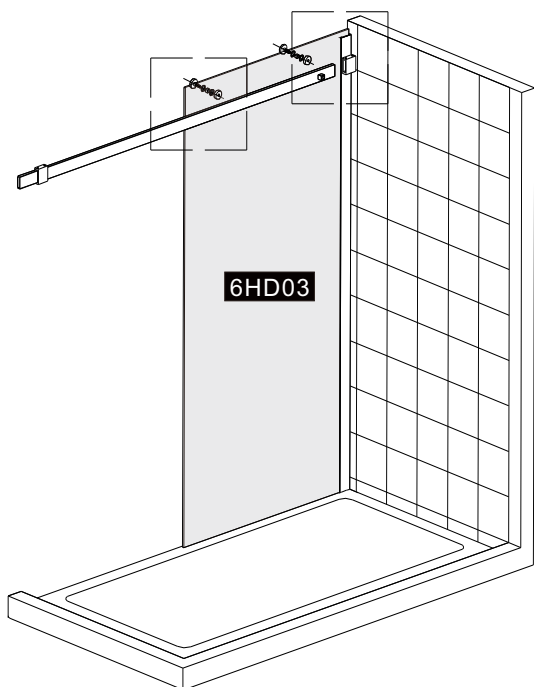

- 6**
- Insert the rail profile into wall bracket next to fixed glass panel again.
  - Put fixing part H of 6HD19(2X) through the holes of the glass panel to reach rail profile. Fasten 6HD19 by hex key.
  - Fix the rail profile and the wall bracket with hex key for both ends.

6HD19		X 2
6HD24		X 1





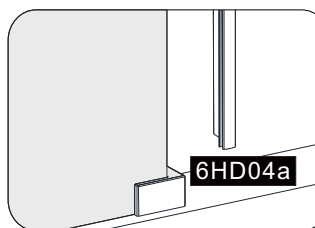
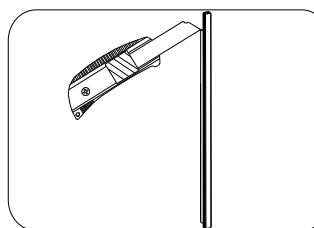
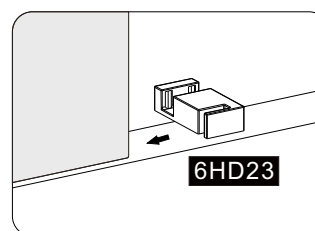
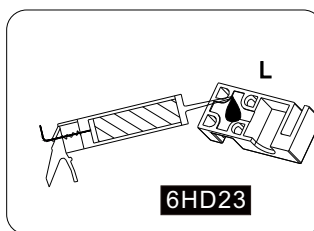
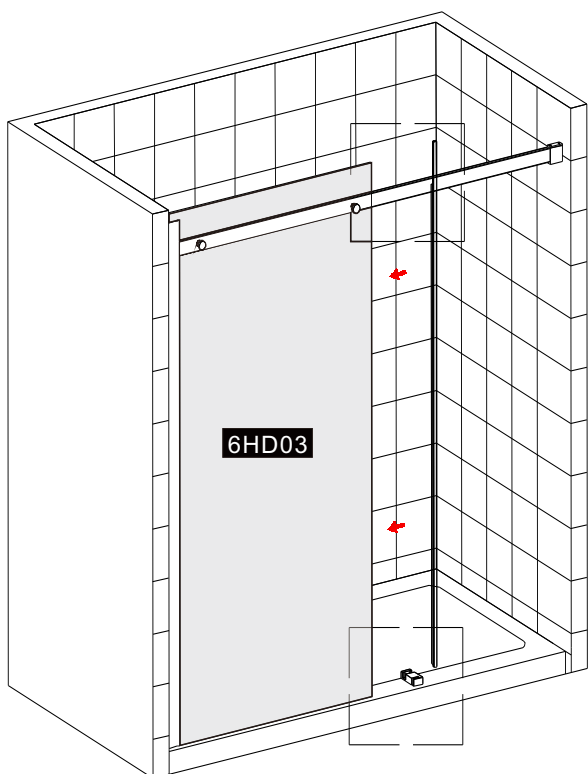

- 7**
- Apply silicone on the back of sliding guide 6HD23.
  - Put it right next to the fixed glass panel.
  - Cut the extra part of vertical seal 6HD04a(1X) under the rail profile, and apply it on the fixing panel.

6HD23		X 1
6HD04		X 1





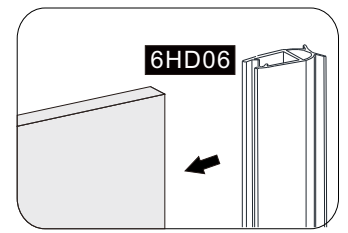
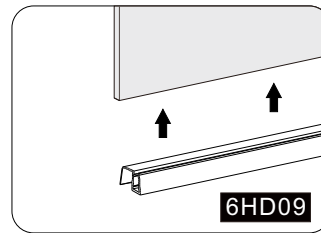
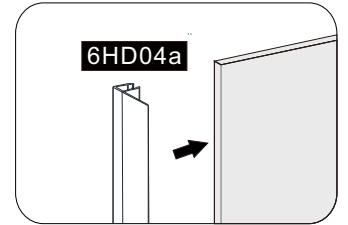
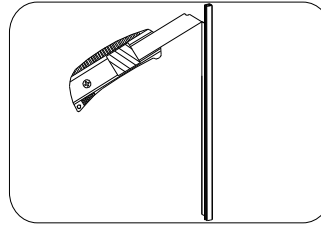
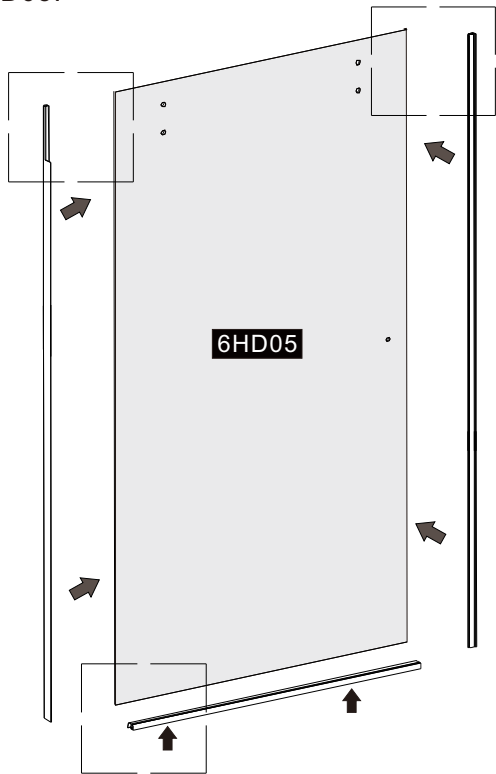

- 8** - Apply vertical seal 6HD04(1X) on the sliding glass panel 6HD05 and cut under the rail profile.  
 - Apply anti-water seal 6HD09 on bottom of the sliding glass panel 6HD05.  
 - Attached the magnetic seal 6HD06 on the edge of sliding glass panel 6HD05.

6HD05		X 1
6HD04		X 1
6HD06		X 1
6HD09		X 1



- 9** - Mount rollers 6HD17(2X) on the sliding glass panel 6HD05.  
 - Mount handle 6HD07 on the sliding glass panel.

6HD17		X 2
6HD07		X 1

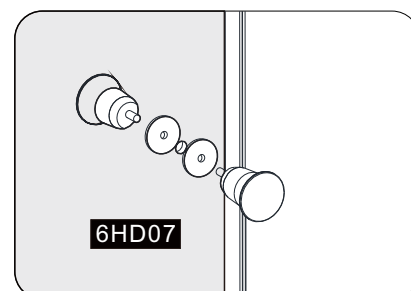
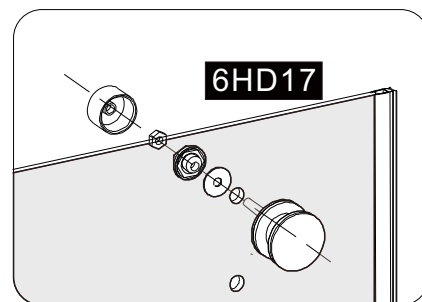
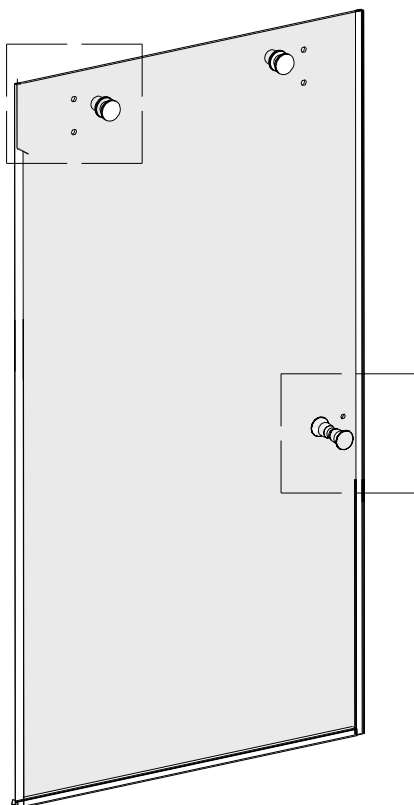

# 10

-Put the sliding glass panel 6HD05 on the rail profile to make sure bottom edge on the channel of sliding guide.

▪Roller adjustment:

-From inside of the cabine, take off the back cover from the roller.

-Turn the nut of the roller with tool 8HD14 until the door is vertical against the magnetic seal well.

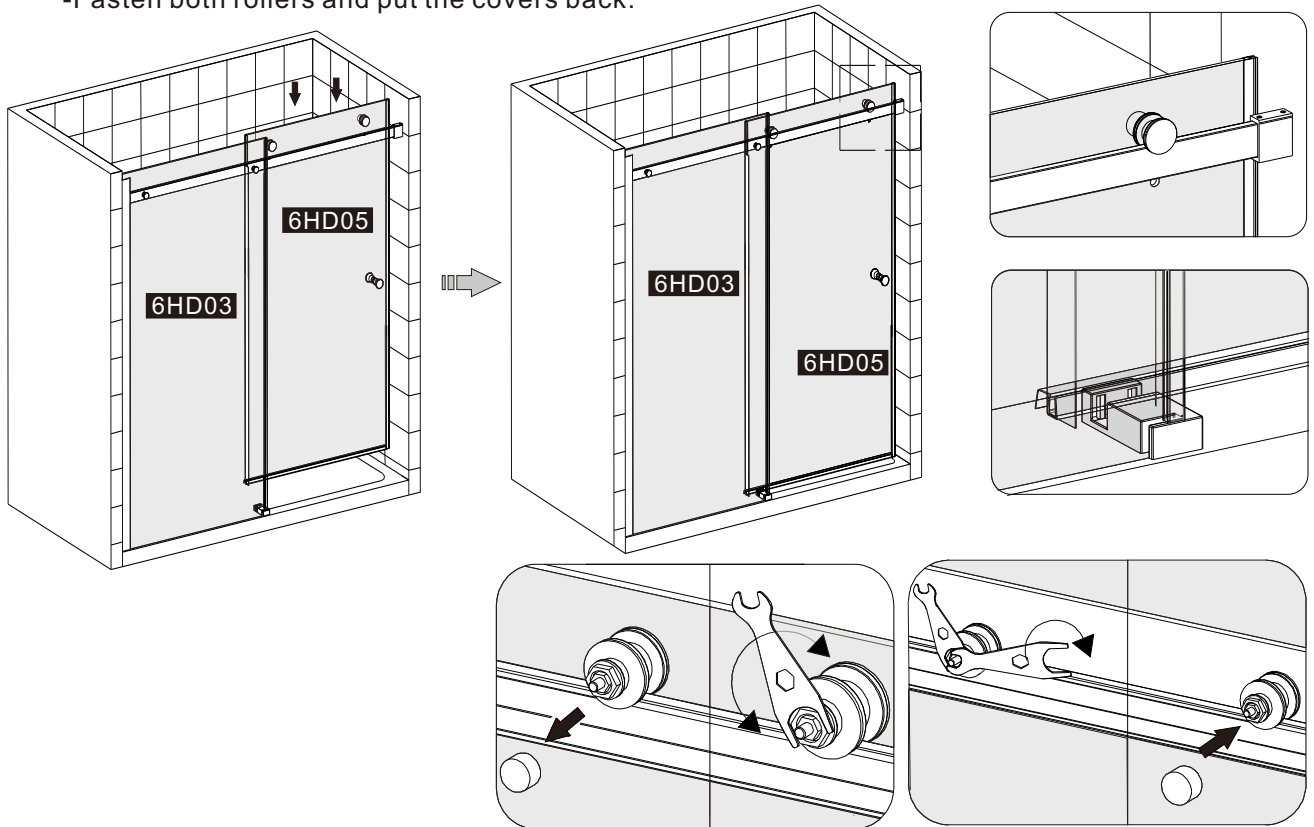

-Fasten both rollers and put the covers back.



# 11



-Mount anti-jump part 6HD18(2X) on the sliding glass panel to keep distance with 1~2mm to rail profile.

▪ Put top cap 6HD21 onto the wall profile.

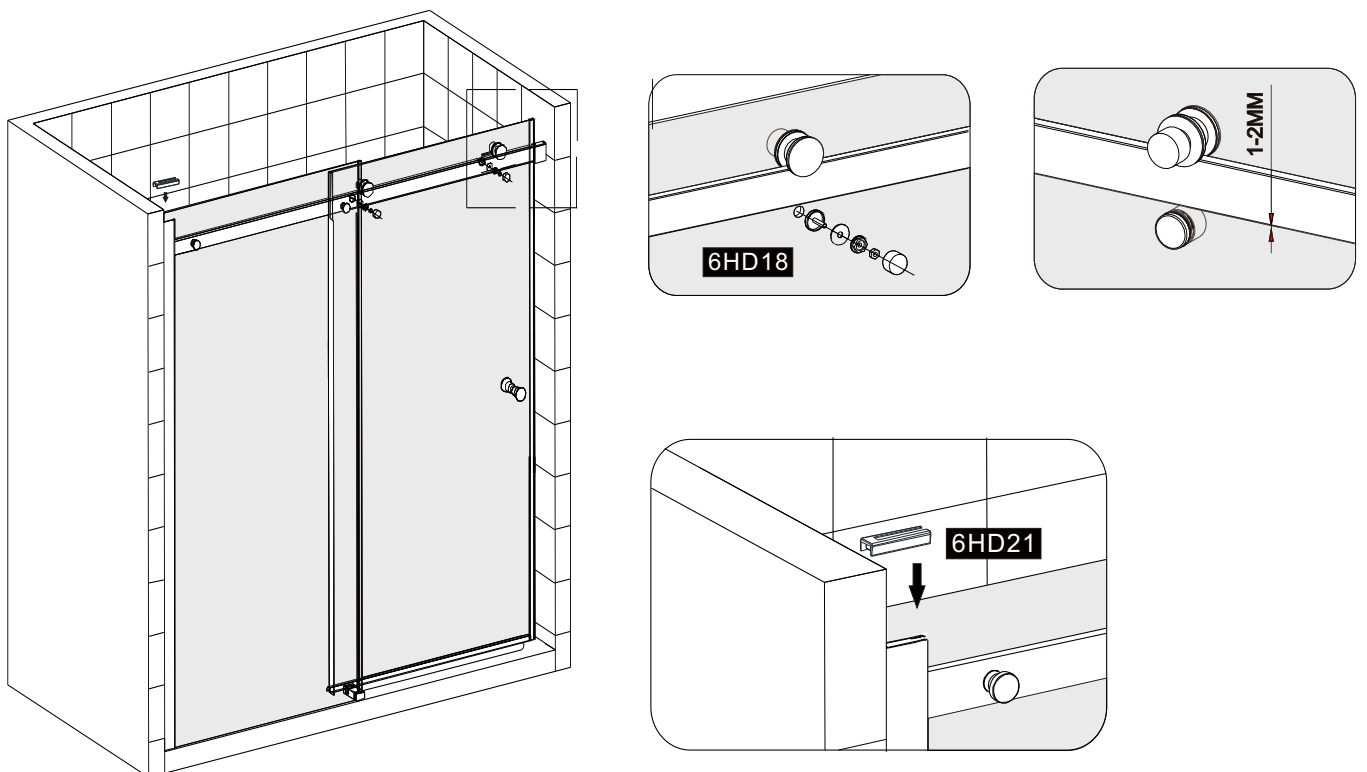
6HD18		X 2
6HD21		X 1



- 12.** -Apply silicone on the back of aluminium anti-water strip 6HD10 and strip cover 6HD22.  
 -Insert 6HD10 into the hole of sliding guide 6HD23.  
 - Put 6HD22 cover on the other end.

6HD10		X 1
6HD22		X 1

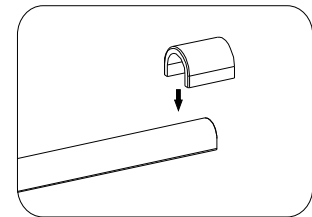
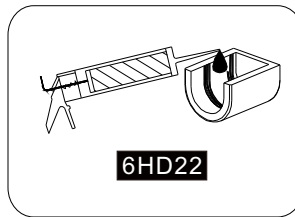
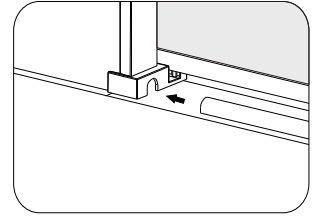
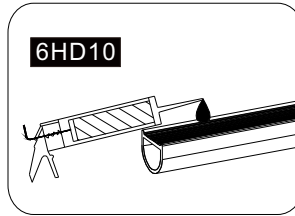
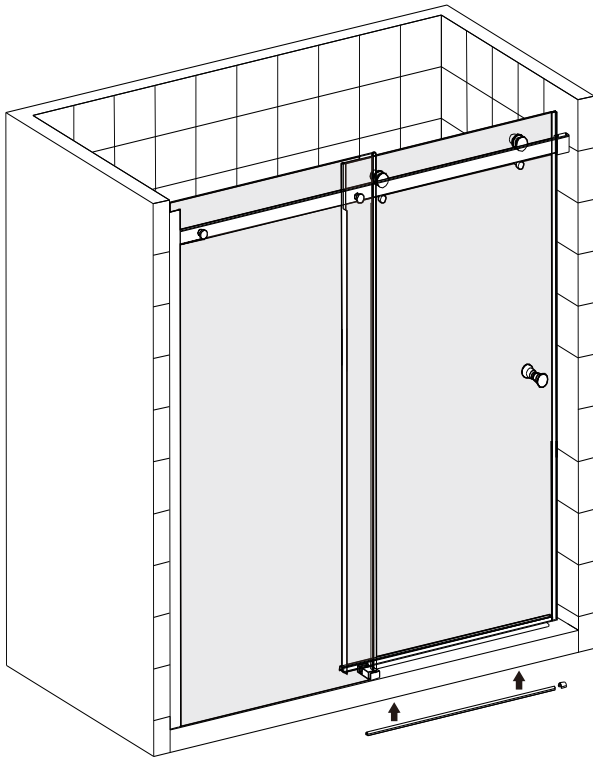

- 13.** Finally, at all points connected to the wall, the bathtub and the profiles, use silicone sealant only on the outside of the shower enclosure. Please do not take shower within 24 hours after silicon sealant.

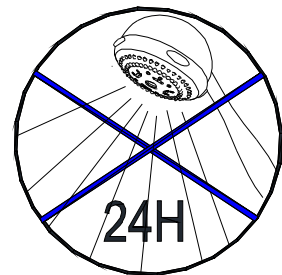
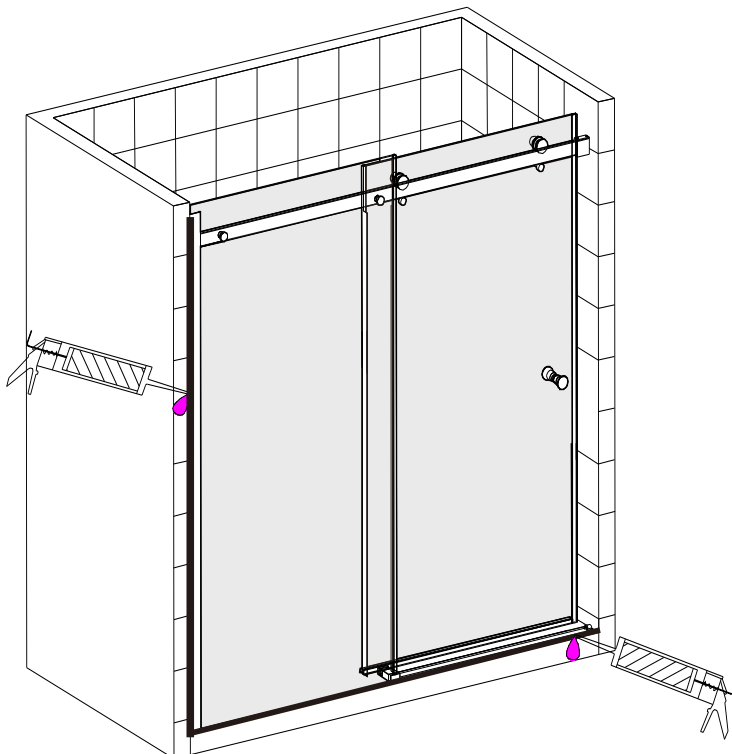

**Cleaning and Maintenance:**

Please do not use abrasive or strong cleaning solutions on the shower enclosure, such as alcohol, petroleum liquids or any other chemical cleaner.

Should there be any dirty stains on the shower enclosure, please clean it with a soft lint free cloth and warm soapy water. Please rinse it with clean water afterwards.

Sealant drying times may vary in cold damp conditions and will be extended where thicker beads of sealant are applied. Allow sealant to dry completely before exposing to water.

We have taken great care to ensure that this product reaches you in perfect condition. However should any parts be damaged or missing please contact your point of purchase. This does not affect your statutory rights. In addition if you require replacement parts your point of purchase will be happy to assist.

**Technical and Customer Support: 800.480.6850**